

”Weatherproof“ for outdoor installation

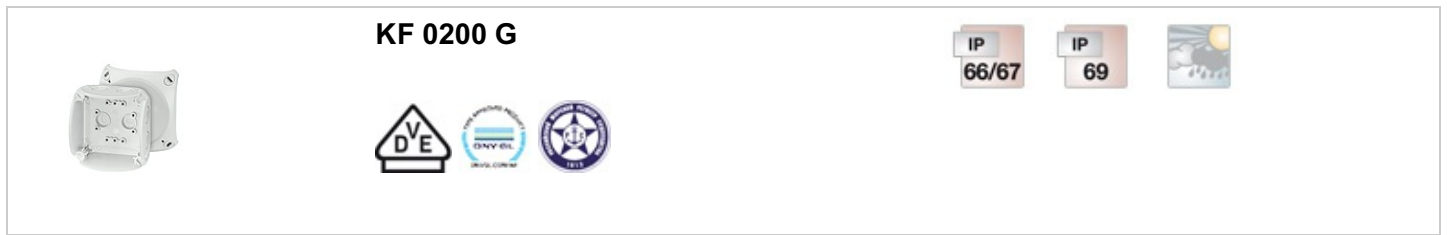

- without terminals
- cable entries via knockouts, order AKM separately (see cable entry systems LES)
- "weatherproof" resistant to weather influences (UV due to solar radiation, protected against rainwater, temperature resistant, impact resistant, etc.)
- saltwater-proof
- "offshore applications"
- lid fasteners sealable without accessories
- retaining strap and external brackets for wall fixing included
- colour: grey, RAL 7035

rated insulation voltage	$U_i = 1000 \text{ V a.c./d.c.}$
material	PC-GFS (polycarbonate)
degree of protection	IP 66 / IP 67 / IP 69 IP 67, temporary submersion IP 69, water pressure max. 100 bar, water temperature max. 80 °C, distance $\geq 0.15 \text{ m}$
mounting width	74 mm
mounting height	74 mm
max. installation depth	47 mm
width	93 mm
height	93 mm
depth	62 mm
weight	0,11 kg
in accordance with	IEC 60670-22
in accordance with	DNV GL - Certificate No: TAE00000EE Russian Maritime Register of Shipping, technical documentation is approved by the letter No. 250-A-1180-108795

Drawings

Dimension drawing

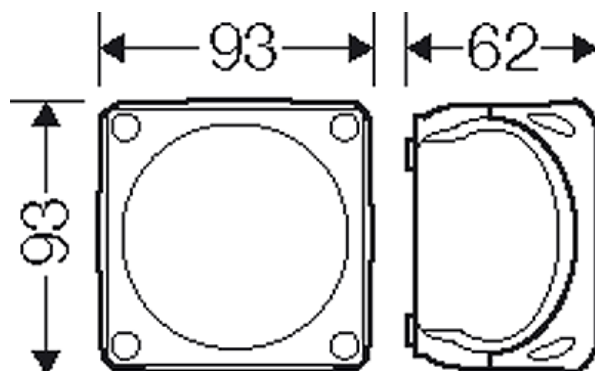

”Weatherproof“ for outdoor installation

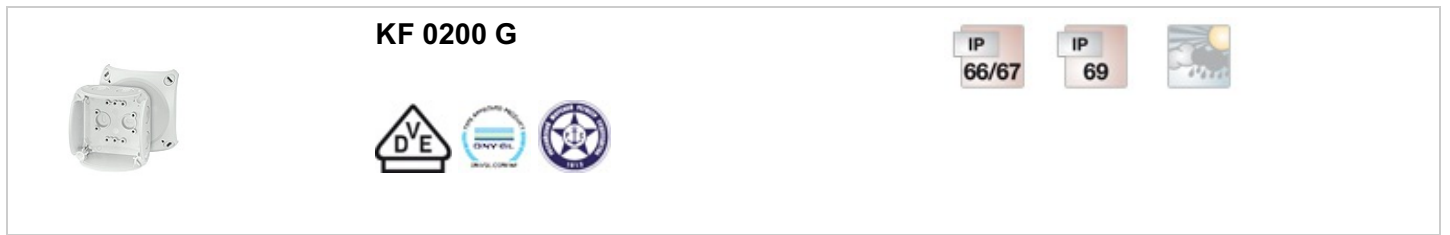

Detail mass

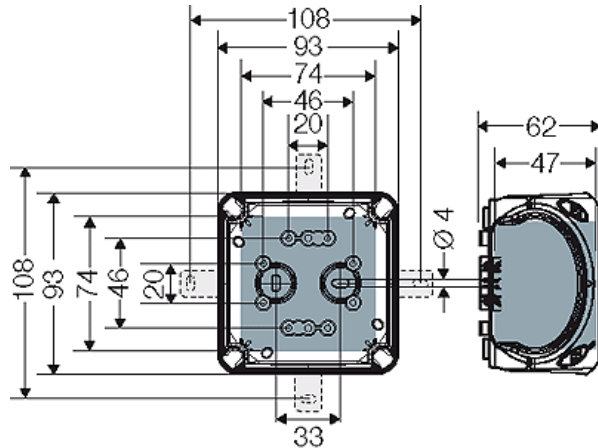



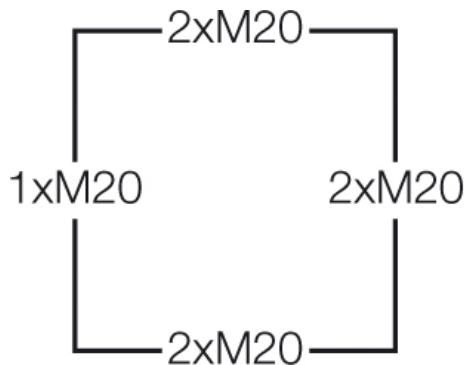

Box walls



**Operating and ambient conditions**

Application area	Suitable for outdoor installation (harsh environment and/or outdoor). To reduce the formation and accumulation of condensed water see technical information.
Resistant to occasional cleaning procedures (direct jet)	Resistance to occasional cleaning procedures (direct jet) with high-pressure cleaner without cleaning additives, water pressure: max 100 bar, water temperature: max 80 °C, distance ≥ 0.15 m, in accordance with DIN EN 60529:2014-09 (IEC 60529:2013) = IP 69. Only with cable entries HENSEL AKM or ASS.
Ambient temperature	Average value over 24 hours + 55 °C Maximum value + 70 °C Minimum value - 25 °C
Fire protection in the event of internal faults	Demands placed on electrical devices from standards and laws Minimum requirements - Glow wire test in accordance with IEC 60695-2-11: - 650°C for boxes and cable glands - 850°C for parts of insulating material necessary to retain current carrying parts in position
Burning behaviour	Glow wire test IEC 60695-2-11: 960 °C UL Subject 94: V-0 flame-retardant self-extinguishing
Degree of protection against mechanical load	IK09 (10 Joule)
Toxic behaviour	halogen-free

”Weatherproof“ for outdoor installation

	<b>KF 0200 G</b>			
				

silicone-free  
"halogen-free" in accordance with the examination of the cables and insulated wires - corrosiveness of fumes - as per IEC 60754-2

Note:

For material properties see technical data.